

Drying Loader

SDL-300U



Refer carefully to the manual before operation.

SDL-U Series

■ Coding Principle

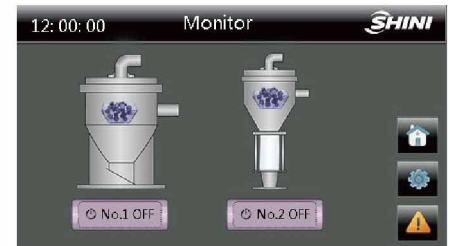
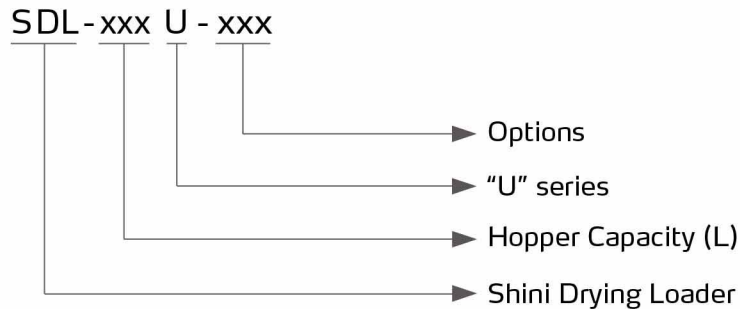

Loading Control

■ Features

- SDL -U integrates two-stage conveying and drying into one unit.
- Microcomputer and P.I.D. control system can accurately control the drying temperature.
- Portable design with standard footprint.
- Material contacted surfaces are made of stainless steel to ensure that materials are free from contamination.
- Full-function alarm system that can immediately respond to error.
- Standard hot air recycler reduces energy consumption without hot air and dust being discharged for cooler and cleaner working space.
- Standard material shut-off suction box formed hermetic cycle loop, to avoid material moisture regain due to ambient air, and ensure that there is no material residue in the pipe.
- Double-layer heat insulation hopper ensures uniform temperature and less heat loss.
- Weekly timer function
- Highest drying temperature of 160°C.
- Touchable HMI that for easy operation and study.

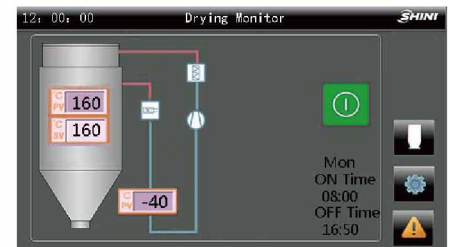

Drying Control



SDL-230U-HD

■ Application

SDL-U drying loader integrates two-stage conveying and drying into single unit, which can efficiently dry most of standard hygroscopic plastics, such as PS, PP, and other plastics. The two-stage conveying can realize fully automatic conveying materials from storage tank to drying hopper, and from drying hopper to the IMM, which reduces men power and avoids contamination. SDL-U-HD drying loader is composed of the SDL-U and optional HAD twin tower compress air dryer to achieve better drying result than ordinary dryers. The weekly timer can reserve working hours in advance that is especially suitable for pre-drying occasions, which is applicable to pre-dry materials before IMM start as to increase productivity.

Application

1. Photosensor hopper receiver
2. Material storage tank
3. Vacuum pipe
4. Material pipe
5. Vacuum hopper receiver
6. Return air
7. SDL-U

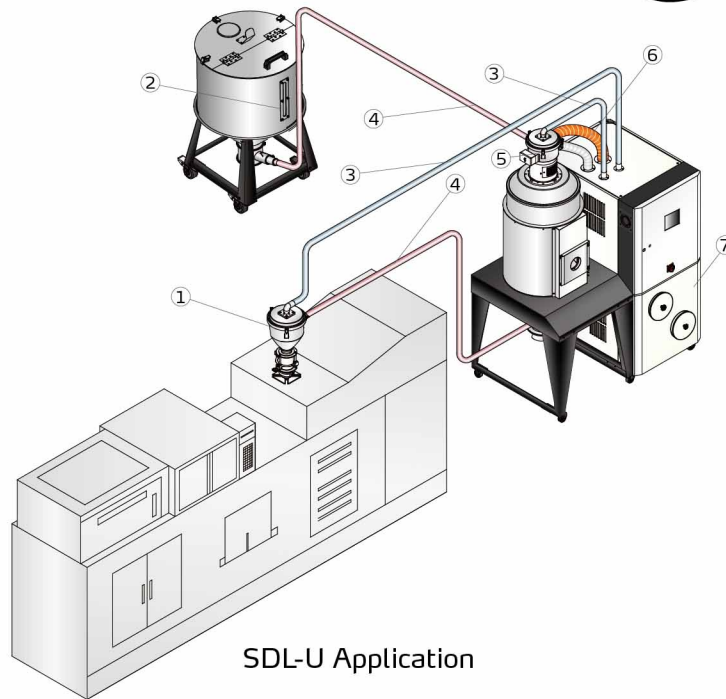

SDL-U Application

Working Principle

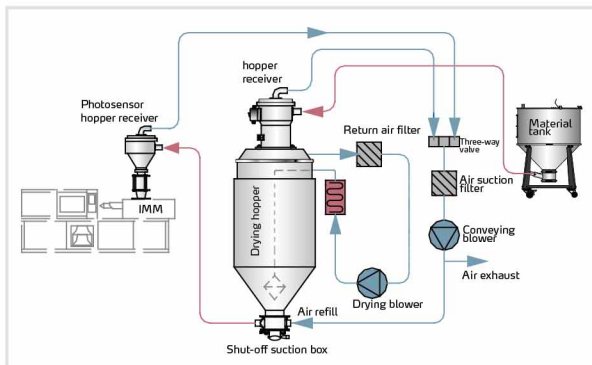

SDL-U Working Principle

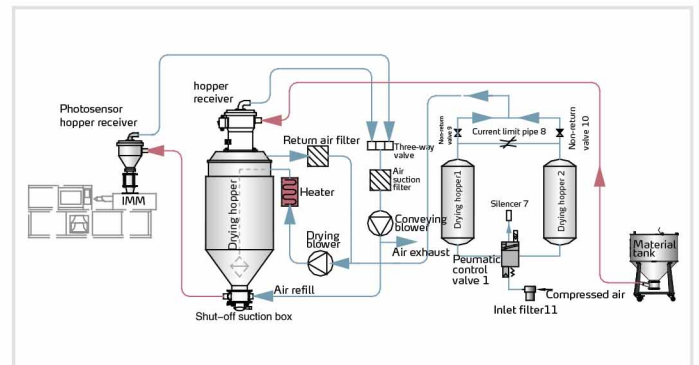

SDL-U-HD Working Principle

Options

- Optional heatless regenerative air dryer, which could offer low dew point air at room temperature and speed up the drying of material, add "HD" at the end of the mode code.
- For models with hopper polished inside, add "P" at the end of the mode code.

SDL-U Series

Outline Drawing

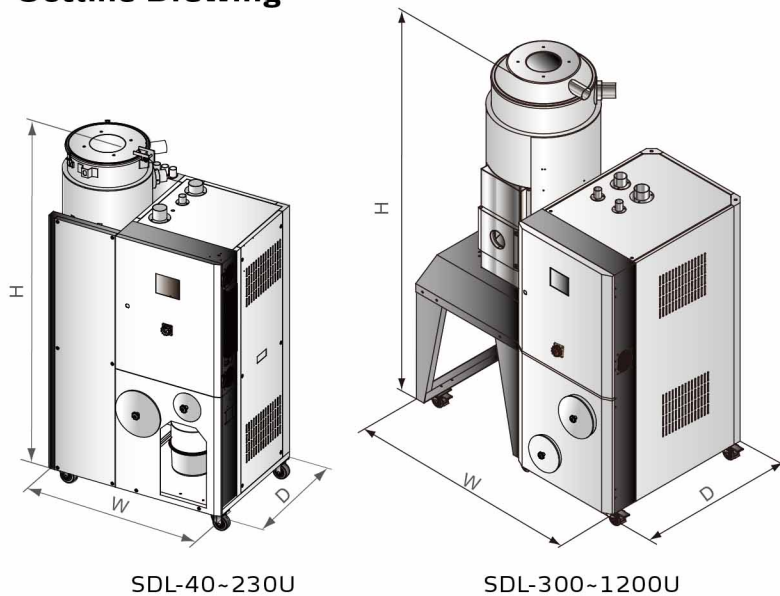

Hopper



SHR-U



SVH

Specifications

| Model | SDL- | 40U (-HD) | 80U (-HD) | 120U (-HD) | 160U (-HD) | 230U (-HD) | 300U (-HD) | 450U (-HD) | 600U (-HD) | 750U (-HD) | 900U (-HD) | 1200U (-HD) | |
|---|------|-----------|-----------|------------|------------|------------|------------|------------|------------|------------|------------|-------------|-------|
| Drying Blower (kW, 50/60Hz) | | 0.12/0.14 | 0.12/0.14 | 0.12/0.14 | 0.12/0.20 | 0.12/0.20 | 0.18/0.28 | 0.18/0.28 | 0.55/0.63 | 0.55/0.63 | 0.55/0.63 | 1.1/1.25 | |
| Conveying Blower (kW, 50/60Hz) | | 1.5/1.8 | 1.5/1.8 | 1.5/1.8 | 1.5/1.8 | 1.5/1.8 | 1.5/1.8 | 1.5/1.8 | 1.5/1.8 | 1.5/1.8 | 3.75/4.7 | 3.75/4.7 | |
| Heater (kW) | | 3 | 3.9 | 3.9 | 6 | 6 | 12 | 12 | 18 | 18 | 18 | 24 | |
| Compressed air flow (m ³ /min) | | 0.1 | 0.23 | 0.3 | 0.4 | 0.5 | 0.6 | 0.7 | 0.8 | 0.9 | 1.0 | 1.3 | |
| Air Inlet Pipe (inch) | | 2 | 2 | 2.5 | 3 | 3 | 3 | 3 | 4 | 4 | 4 | 4 | |
| Air Return Pipe (inch) | | 2 | 2 | 2.5 | 2.5 | 2.5 | 2.5 | 2.5 | 3 | 3 | 4 | 4 | |
| Material Pipe (inch) | | 1.5 | 1.5 | 1.5 | 1.5 | 1.5 | 1.5 | 1.5 | 1.5 | 1.5 | 2 | 2 | |
| Drying Hopper Capacity | L | 40 | 80 | 120 | 160 | 230 | 300 | 450 | 600 | 750 | 900 | 1200 | |
| | gal | 10.6 | 21 | 31.7 | 42.3 | 60.8 | 79.3 | 118.9 | 158.5 | 198 | 237.8 | 317 | |
| SVH-L Hopper | L | 3 | 6 | 6 | 6 | 12 | 12 | 12 | 12 | 12 | 24 | 24 | |
| | gal | 0.79 | 1.59 | 1.59 | 1.59 | 3.17 | 3.17 | 3.17 | 3.17 | 3.17 | 6.34 | 6.34 | |
| SHR-U Hopper | L | 3 | 6 | 6 | 6 | 12 | 12 | 12 | 12 | 12 | 24 | 24 | |
| | gal | 0.79 | 1.59 | 1.59 | 1.59 | 3.17 | 3.17 | 3.17 | 3.17 | 3.17 | 6.34 | 6.34 | |
| Dimension | W | mm | 1081 | 1097 | 1159 | 1159 | 1159 | 1400 | 1400 | 1960 | 1960 | 1960 | 1960 |
| | | Inch | 42.6 | 43.2 | 45.6 | 45.6 | 45.6 | 55.1 | 55.1 | 77.1 | 77.1 | 77.1 | 77.1 |
| | D | mm | 841 | 841 | 841 | 841 | 841 | 1000 | 1000 | 1450 | 1450 | 1450 | 1450 |
| | | Inch | 33.1 | 33.1 | 33.1 | 33.1 | 33.1 | 39.4 | 39.4 | 57.1 | 57.1 | 57.1 | 57.1 |
| | H | mm | 1685 | 1771 | 1957 | 2102 | 2102 | 2020 | 2420 | 2450 | 2720 | 2610 | 3030 |
| | | Inch | 66.3 | 69.7 | 77 | 82.8 | 82.8 | 79.5 | 95.3 | 96.5 | 107 | 102.8 | 119.3 |
| Weight | kg | 120 | 130 | 195 | 215 | 240 | 310 | 350 | 435 | 500 | 550 | 600 | |
| | lb | 265 | 287 | 430 | 474 | 529 | 683 | 772 | 959 | 1,102 | 1,213 | 1323 | |

Notes: 1) Compressed air pressure suggested: 4~6kg/fcm²;
The compressed air pressure is ≥6kg/fcm² with option of 'HD'.
2) Power: 3Φ, 230/400/460/575VAC, 50/60Hz.

We reserve the right to change specifications without prior notice.

Shini Group

Addr: No. 23, Minhe St., Shulin Dist.,
New Taipei, Taiwan

Tel: +886 2 2680 9119

Fax: +886 2 2680 9229

Email: shini@shini.com

Factories:

- Taiwan
- Dongguan
- Pinghu
- Ningbo
- Chongqing
- Pune