



PET special "All-in-One" Compact Dryer



Refer carefully to the manual before operation.

SCD-PET Series

■ Coding Principle

SCD-xxxU-PET-xxx

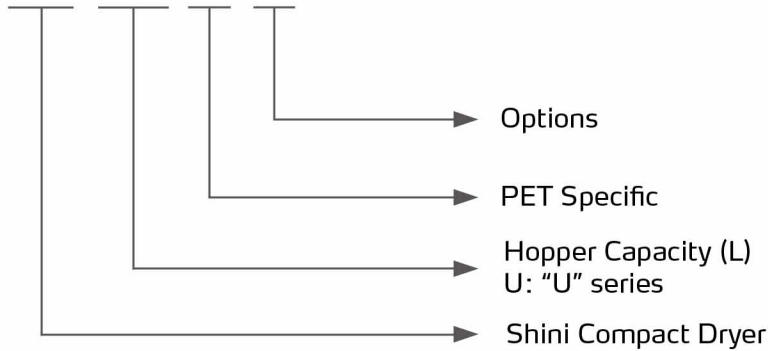

■ Features

- Combine the function of dehumidifying, drying and two-stage conveying into a single unit, Specially designed for PET .
- Adopt molecular sieve structure honeycomb rotor, which provides low dew-point dry air. The honeycomb rotor structure is superior to double-barrel dehumidifier that will contaminate raw material due to damaged molecular sieve.
- Feeding system is equipped with shut-off valve to ensure no dry materials remain in the material line and avoid dry material from regaining moisture.
- Insulation drying hopper adopts down blowpipe design and collocates with cyclone air exhaust to avoid heat lost and improve drying efficiency.
- Equipped with a high-temperature heating box to effectively and quickly remove moisture
- Equipped with weekly timer, machine can automatically operate.
- ACF is standard equipped for SCD-1500U-PET and above models.

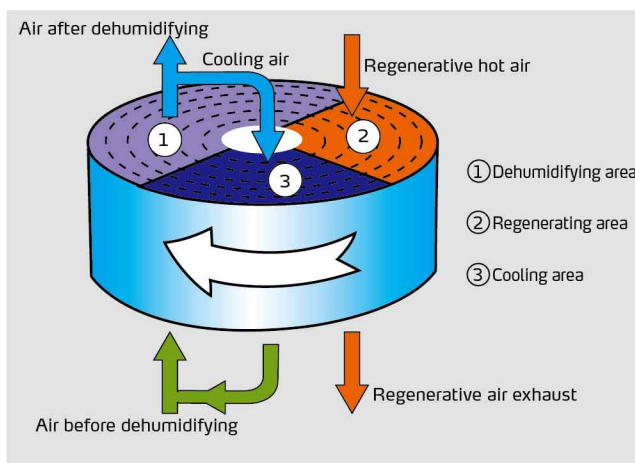

Honeycomb Rotor Working Principle

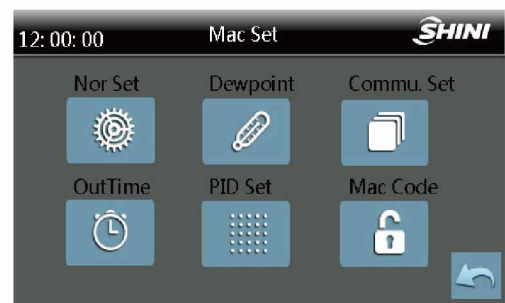

Touch Control Panel

Application

SCD "All-in-One" portable compact dryers are mainly used for drying, dehumidifying, and conveying hygroscopic plastics. Simple appearance structure facilitates the on-demand movement of the machine. Rich optionals and accessories meet diverse specific needs. If the dry material has a lot of dust, it needs to be used in conjunction with an ACF.

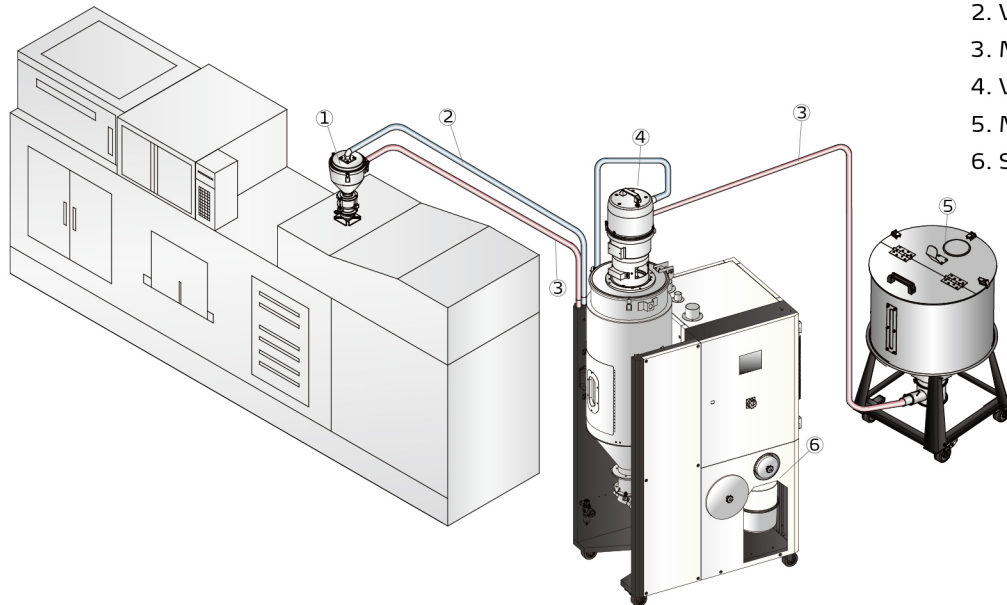

1. Photosensor hopper receiver
2. Vacuum pipe
3. Material pipe
4. Vacuum hopper receiver
5. Material storage tank
6. SCD Main unit

For Servicing One Machine: Two-stage Conveying System (Standard)

Working Principle

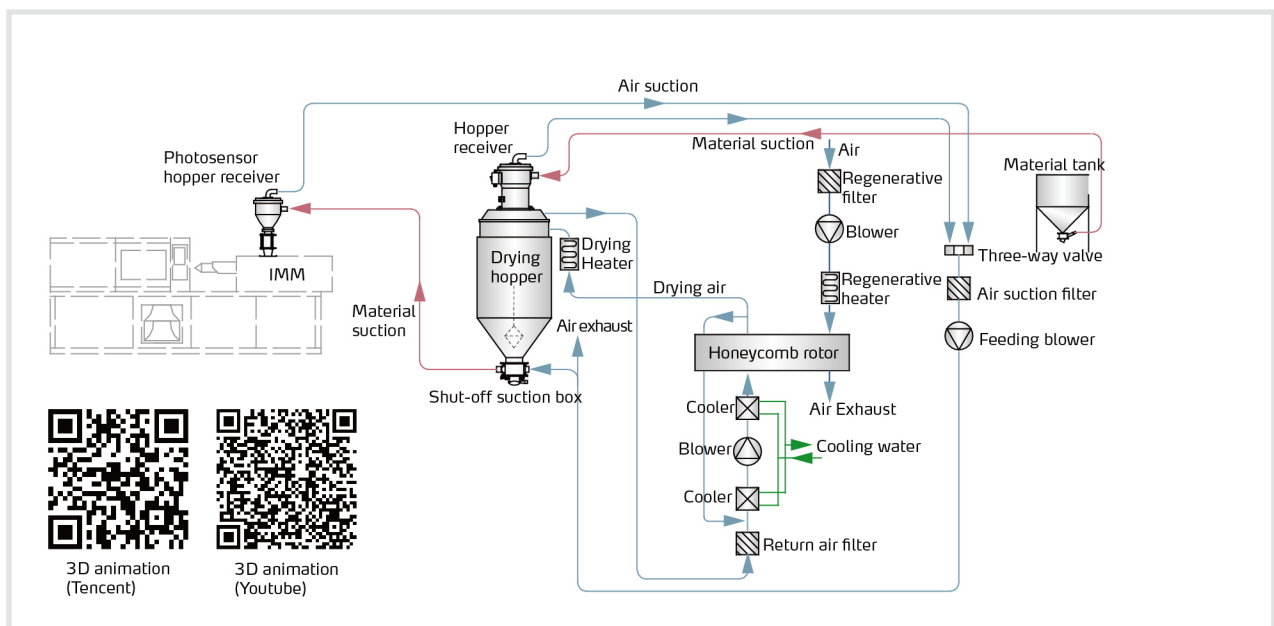

SCD-PET Series

Outline Drawings

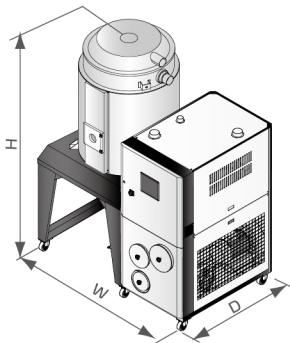

SCD-2500U and above

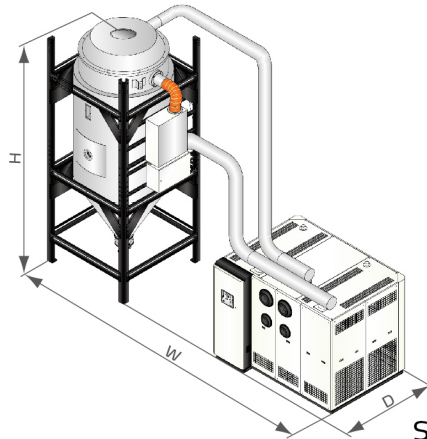

SCD-3000U and above

Specifications

Model SCD-PET	600U	750U	900U	1200U	1500U	2000U	2500U	3000U	3500U	4000U	5000U	6000U	7000U	8000U
Drying air volume (m ³ /hr)	400	400	500	700	700	1000	1000	1500	2000	2000	2000	3000	3000	4000
Effective Capacity (L)	600	750	900	1200	1500	2000	2500	3000	3500	4000	5000	6000	7000	8000
Max. Temp.(°C)	195	195	195	195	195	195	195	195	195	195	195	195	195	195
Drying Heater (kW)	24	24	24	32	32	58	58	72	80	80	80	128	128	168
Drying Blower (kW)	1.5	1.5	2.2	2.2	3.7	5.5	5.5	11	11	11	11	15	15	18.5
Regenerative Heater (kW)	7.2	7.2	10	10	12	12	12	15	15	15	15	30	30	30
Regenerative Blower (kw)	0.85	0.85	1.6	1.6	1.6	1.6	1.6	2.2	2.2	2.2	2.2	5.5	5.5	7.5
Conveying Blower (kw)	2.2	2.2	2.2	2.2	3	3	4	4	4.3	4.3	7.5	7.5	11	11
Dia. of Material Pipe(inch)	1.5	1.5	1.5	1.5	2	2	2	2	2	2	2	2	2.5	2.5
Actual Capacity (kg)	400	600	800	1000	1200	1600	2000	2400	2800	3200	4000	4800	5600	6400
Cooling water (L/min)	50	50	80	80	80	120	120	180	240	240	240	360	360	480
Inlet/outlet pipe threads(PT)(inch)	0.75	0.75	1	1	1	1.5	1.5	1.5	2	2	2	2	2	2
SVH-L(L)	12	12	24	24	/	/	/	/	/	/	/	/	/	/
SHR-U(L)	12	12	24	24	24*2	24*2	36*2	36*2	48*2	48*2	96*2	96*2	120*2	120*2
SICH(L)	/	/	/	/	24	24	36	36	48	48	96	96	120	120
H(mm)	2380	2380	2750	3170	3450	4000	4050	4485	4485	4670	4700	5450	5840	6425
W(mm)	1845	1845	2175	2175	2300	2910	2910	4065	4225	4225	4425	4425	4500	4500
D(mm)	1255	1255	1680	1680	2120	2285	2465	2175	2400	2400	2600	2600	2650	2650
Weight(kg)	500	700	900	1100	1440	1550	1660	2000	2200	2400	2600	3000	3330	3620

Notes: 1) Above maximum processing, capacity is obtained based on PET material (amorphous PET) of 0.85 kg/L in bulk density and 3-5mm in diameter under the temperature of 195°C;

2) Power: 3Φ, 230/400/460/575VAC, 50/60Hz.

We reserve the right to change specifications without prior notice.

Shini Group

Addr: No. 23, Minhe St., Shulin Dist.,
New Taipei, Taiwan

Tel: +886 2 2680 9119

Fax: +886 2 2680 9229

Email: shini@shini.com

Factories:

- Taiwan
- Dongguan
- Pinghu
- Ningbo
- Chongqing
- Pune